

Simulation of a 2-Channel Broadband Feedforward Active Control of Noise with Arbitrary Direction

Hatem Foudhaili, Eduard Reithmeier

Institute for Measuring Engineering and Automatic Control, University of Hanover,
Germany

Hatem.Foudhaili@imr.uni-hannover.de

Eduard.Reithmeier@imr.uni-hannover.de

Abstract. This paper presents a simulative approach for a 2-channel broadband feedforward Active Noise Control (ANC). Common feedforward ANC applications condition the availability of coherent reference signals at the algorithm input to proceed control. This controller was designed to recognize if the supplied signal is unusable and inhibit it in order to avoid additive noise and performance deterioration. The cancelling is possible when at least one of the two channels provides a coherent reference signal.

1 Problem Statement

Active Noise Control (ANC) systems attempt to neutralize undesired acoustic noise via some appropriate antinoise signal generated by a secondary sound source. The Noise Cancellation occurs in a specified area, where an error microphone is placed. As shown

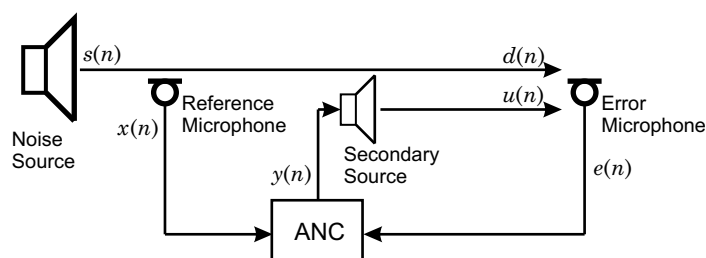

Figure 1: Feedforward ANC system

in Figure (1) for discrete-time signals, a feedforward ANC system attempts to cancel the disturbing noise $d(n)$ by taking an "upstream" reference input $x(n)$ into account. Therefore, a reference microphone is generally placed close to the primary sound source to detect a reference input signal. This reference $x(n)$ must give a sufficiently advanced and coherent indication of the approaching noise. After the reference signal is picked

up by the reference microphone, the ANC system calculates the output to the secondary source $y(n)$ that minimizes the resulting overlap signal $e(n)$. Two major constraints affect the efficiency of a feedforward ANC system, coherence and causality.

Coherence. The ANC system neutralizes only the part of the disturbance $d(n)$ which is correlated with the reference $x(n)$. Uncorrelated noise for example due to flow noise added at the error microphone would not be cancelled out in general since no information about this flow noise is included in the reference.

Causality. After disposing of the reference signal, the ANC system will have some time to calculate the output to the secondary source $y(n)$. If this electrical delay becomes longer than the acoustic delay from the reference microphone to the secondary source, the performance of the system will be degraded. That is, because the ideal response, from the point of view of the controller, is noncausal when the electrical delay is longer than the delay due to the acoustic wave propagation.

Consider now the Problem of designing a feedforward adaptive controller to cancel a broadband acoustic disturbance $d(n)$ caused by a primary noise $s(n)$, which is generated at an arbitrary position with respect to the reference microphone placement. In case the location of the primary noise source is closer to the error microphone than to the reference microphone, as shown in Figure (2), the control problem becomes noncausal. That means that an usual broadband single-channel feedforward ANC could not work properly because the disturbing signal to be cancelled out will arrive first at the error microphone.

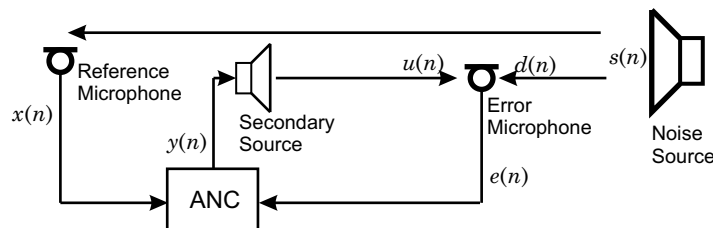

Figure 2: Noncausal feedforward ANC problem

In this paper a simulative approach of a 2-channel feedforward ANC is proposed that cancels a disturbing noise regardless of the relative position of the primary noise source to the reference and error microphones

2 State of the Art

Most successful broadband ANC applications are single channel systems (one reference and one error microphone) where the primary and secondary sources of sound are locally fixed. The causality constraint holds if an adequate position of the error microphone is determined such that an advanced and coherent indication of the primary noise is detected. Successful applications are found for one-dimensional ducts used in ventilation and air conditioning systems, and for engine noise cancellation, as related in [1].

Multiple-channel feedforward ANC applications have been demonstrated for use in enclosures such as automobile and aircraft cabins, free-field transformer noise, and in large-

dimensional ducts. In the case of more than one primary noise source, the problem was solved through aimed positioning of reference microphones close to known primary noise sources for maximum coherence with respect to the noise to be cancelled out and with respect to the time delay of the reference signal [2].

Thus, most applications are based on locally fixed and well defined primary noise sources. The approach shown in this work attempts to attenuate a disturbance coming from an arbitrary source.

3 Modelling

The main idea of this approach is to place two reference microphones to the right and to the left of the error microphone, as shown in Figure (3). Thus, two reference signals $x_l(n)$ and $x_r(n)$ are available for the ANC system. The signal caught by the reference microphone which is closer to the primary source may be used since the causality constraint holds. Accordingly, the second reference signal which is delayed with respect to the disturbance $d(n)$ to be cancelled out, cannot be used.

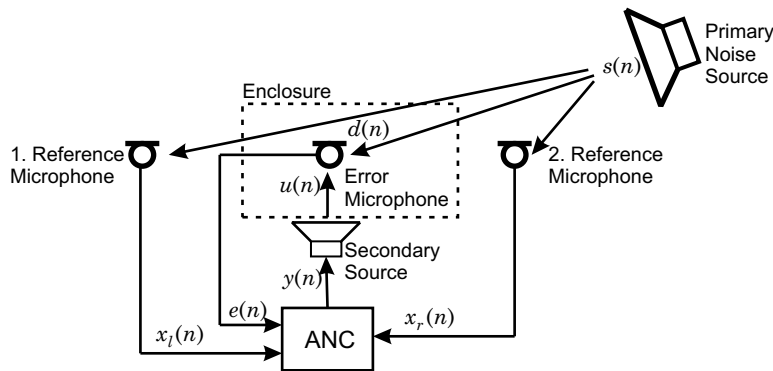

Figure 3: 2-input-channel feedforward ANC system

Thus, regardless of the position of the primary noise source, at least one reference signal could be used to attenuate the disturbance $d(n)$. In a second step, the feedforward ANC system has to be designed in such a way that the incoherent channel will be recognized and neglected.

The system model is illustrated in Figure (4). The primary noise $s(n)$ propagates to the three microphones and will result in three output sensor signals $d(n)$, $x_l(n)$, and $x_r(n)$. The transfer function from the primary noise source to the error microphone is $\mathbf{F}_e(z)$, while the transfer functions to the left and right reference microphones are $\mathbf{F}_{rl}(z)$ and $\mathbf{F}_{rr}(z)$, respectively. The complete transfer function from the ANC electrical output $y(n)$ to the error microphone electrical output $u(n)$ is $\mathbf{F}_2(z)$, which is commonly called "Secondary Transfer Path". All signals illustrated in Figure (4) are electrical voltages. Thus, all the transfer functions of the model considered include both electrical and acoustical effects.

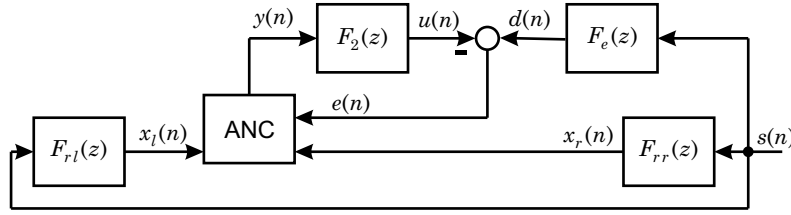

Figure 4: Block diagram of 2-input-channel feedforward ANC system

4 Controller Design

In order to attenuate the disturbance $d(n)$, an adaptive filtering technique called FXLMS (Filtered Least Mean Square) was used. The common FXLMS Algorithm attempts to minimize some predetermined performance criterion by employing the two signals, the error to be minimized $e(n)$ and the reference signal $x(n)$. The reference signal $x(n)$ is passed through an adaptive filter $\mathbf{W}(z)$ whose parameters $w_i(n)$ are adapted by the FXLMS algorithm such that the filter output $y(n)$, after traversing the secondary transfer path, cancels the disturbance $d(n)$. Using a FIR Filter, the filter equation is written,

$$y(n) = \mathbf{W}^T \cdot \mathbf{X}(n) \quad (1)$$

with $\mathbf{W}^T = [w_1, w_2, \dots, w_L]$
and $\mathbf{X}^T = [x(n), x(n-1), \dots, x(n-L+1)]$

and the error microphone output,

$$e(n) = d(n) - \mathbf{f}_2(n) * y(n) \quad (2)$$

where $\mathbf{f}_2(n)$ is the impulse response of secondary path $\mathbf{F}_2(z)$ at time n , and $*$ denotes the linear convolution.

The performance criterion to be minimized is the mean-square error (MSE)

$$\xi(n) \equiv \mathbf{E}[e^2(n)] \quad (3)$$

where $\mathbf{E}[\cdot]$ denotes the expected value. The LMS algorithm proposed by Widrow [3] gives a method to minimize the mean square error. The FXLMS algorithm is a modification for systems with secondary path. A derivation of the algorithm is given in [1].

In this application two FXLMS algorithms were used, one unique reference signal for each one. Both were feeded with the same error signal, as illustrated in Figure (5). The resulting sum $y(n) = y_c(n) + y_i(n)$ was used as input of the secondary loudspeaker.

The outputs of the two filters are

$$y_c(n) = \mathbf{W}_c^T \cdot \mathbf{X}_c(n)$$

and $y_i(n) = \mathbf{W}_i^T \cdot \mathbf{X}_i(n)$

and the error is expressed by

$$e(n) = d(n) - \mathbf{f}_2 * \mathbf{W}_c^T \cdot \mathbf{X}_c(n) - \mathbf{f}_2 * \mathbf{W}_i^T \cdot \mathbf{X}_i(n). \quad (4)$$

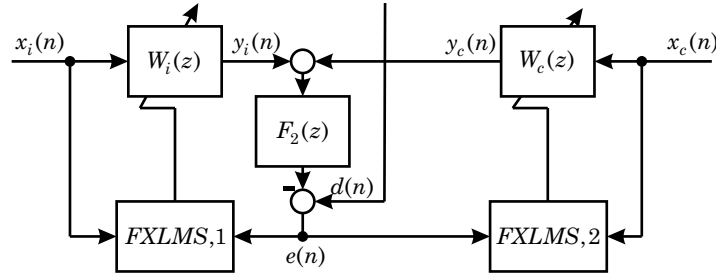

Figure 5: Optimization structure of the 2-input-channel feedforward ANC system

Although, each filter is optimized by its own algorithm, the two algorithms are not independent because of sharing the same error signal $e(n)$. A central question has to be answered: What could happen if one reference signal is completely incoherent to the disturbance $d(n)$ and therefore totally unusable? If the algorithm dealing with the unusable signal disturbs the system in terms of deteriorating the convergence or the minimization of the mean square error, the proposed control would not be able to fulfil the aimed function.

To answer this question, let us consider equation (4):

$$e(n) = e_c(n) - y_i(n) \quad (5)$$

$$\text{with } e_c(n) = d(n) - \mathbf{f}_2 * \mathbf{W}_c^T \cdot \mathbf{X}_c(n) \quad (6)$$

$$\text{and } y_i(n) = \mathbf{f}_2 * \mathbf{W}_i^T \cdot \mathbf{X}_i(n). \quad (7)$$

And, furthermore, let us assume that the reference signal $x_c(n)$ is coherent to the disturbance $d(n)$ while the reference signal $x_i(n)$ is independent of both, $x_c(n)$ and $d(n)$. Hence, according to equation (6) and (7) we state that $e_c(n)$ is independent of $y_i(n)$. Finally, we assume that the mean value of $d(n)$, $x_c(n)$, and $x_i(n)$ is zero.

In compliance with equation (5), we write the mean square error

$$\mathbf{E}[e(n)^2] = \mathbf{E}[e_c(n)^2] - 2 \cdot \mathbf{E}[e_c(n) \cdot y_i(n)] + \mathbf{E}[y_i(n)^2]. \quad (8)$$

Since $e_c(n)$ and $y_i(n)$, as stated above, are independent, equation (8) leads to

$$\mathbf{E}[e(n)^2] = \mathbf{E}[e_c(n)^2] - 2 \cdot \mathbf{E}[e_c(n)] \cdot \mathbf{E}[y_i(n)] + \mathbf{E}[y_i(n)^2]. \quad (9)$$

Since the mean values of $d(n)$, $x_c(n)$, and $x_i(n)$ are considered to be zero, the mean values of $e_c(n)$ and $y_i(n)$ are zero too; (cf. equation (6) and (7)). Hence, equation (9) is reduced to

$$\mathbf{E}[e(n)^2] = \mathbf{E}[e_c(n)^2] + \mathbf{E}[y_i(n)^2]. \quad (10)$$

Since all expected values given in equation (10) are positive, we obtain for the minimal values:

$$\mathbf{E}_{\min}[e(n)^2] = \mathbf{E}_{\min}[e_c(n)^2] + \mathbf{E}_{\min}[y_i(n)^2]. \quad (11)$$

Thus, minimizing the mean square of the error results in minimizing both components $\mathbf{E}[e_c(n)^2]$ and $\mathbf{E}[y_i(n)^2]$ independently.

According to equation (6) and (7) (see also Figure (5)), $\mathbf{E}[e_c(n)^2]$ is only affected by \mathbf{W}_c while $\mathbf{E}[y_i(n)^2]$ is only affected by \mathbf{W}_i . Taking this in account, both algorithms FXLMS,1 and FXLMS,2 work independently and each algorithm would attempt to minimize its part of the whole expecting $\mathbf{E}[e(n)^2]$. If the algorithms converge, the algorithm optimizing \mathbf{W}_c will converge to the optimal solution $\mathbf{W}_{c,opt}$ minimizing $\mathbf{E}[e_c(n)^2]$. And, the algorithm optimizing \mathbf{W}_i will converge to the optimal solution $\mathbf{W}_{i,opt}$ minimizing $\mathbf{E}[y_i(n)^2]$. We obtain

$$\mathbf{E}_{\min}[e_c(n)^2] = \mathbf{E}[(d(n) - \mathbf{f}_2 * \mathbf{W}_{\text{opt},c}^T \cdot \mathbf{X}_c(n))^2] \quad (12)$$

$$\text{and } \mathbf{E}_{\min}[y_i(n)^2] = \mathbf{E}[(\mathbf{f}_2 * \mathbf{W}_{\text{opt},i}^T \cdot \mathbf{X}_i(n))^2]. \quad (13)$$

Equation(13) leads obviously to

$$\mathbf{E}_{\min}[y_i(n)^2] = 0, \quad \text{if } \mathbf{W}_i^T = [0, 0, \dots, 0]. \quad (14)$$

In other words: If a reference signal is independent of the disturbance $d(n)$ to be cancelled out, the best one can do is not using this reference. That is equivalent to assign zero values for the filter parameters in that case.

5 Numerical Example

The controller illustrated in Figure (5), was tested in a simulation with real data input. For this purpose an experimental set up was realized, as illustrated in Figure (3). In addition to the measured reference signals by the microphones, they will also detect the cancelling noise coming from the secondary source, which could destabilize the system. There are simple methods to eliminate the feedback effect of the secondary source. However, in the proposed control we neglected this added component for the purpose of convenience. In order to match this assumption through an experimental set up, the error microphone and the secondary source were placed in an enclosure, as shown in Figure (3), which limits the effect of secondary source sound at the reference microphones.

A white noise signal was generated and used as input of the primary sound source. The outputs of the three microphones were measured. Subsequently, a white noise signal was used as input of the secondary sound source and the response at the error microphone was measured. Based on that measurements the frequency responses of the transfer functions $\mathbf{F}_e(z)$, $\mathbf{F}_{ri}(z)$, $\mathbf{F}_{rr}(z)$, and $\mathbf{F}_2(z)$ were approximated by FIR filters. The identified transfer functions were used in numerical simulations. Two simulations have been carried out.

Incoherent reference. Objective was, to demonstrate the performance of the controller if it is simultaneously feeded with coherent and incoherent reference signals with respect to the disturbance. Two independent white noise signals $s_1(n)$ and $s_2(n)$ were generated and used to build disturbance and reference signals as follows

$$d(n) = \mathbf{F}_e(z) \cdot s_1(n) \quad (15)$$

$$x_1(n) = \mathbf{F}_{rr}(z) \cdot s_1(n) \quad \text{and} \quad x_2(n) = \mathbf{F}_{rr}(z) \cdot s_2(n). \quad (16)$$

Only the reference signal $x_1(n)$ is coherent with the disturbance. The proposed controller, as shown in Figure (5) was supplied with both references. For realizing the controller adaptive filters, FIR filters with length 60 were used. The optimization of filter parameters was performed according to the FXLMS technique, which consists in minimizing recursively the mean square error by using the method of steepest descent. All initial values of the filter parameters were set to 0,1.

Coherent but delayed reference. Objective was, to demonstrate the performance of the controller if it is simultaneously feeded with two coherent references, where one of them was delayed in respect to the disturbance. In the case of a delayed reference signal, the optimal filter which could cancel an earlier coming broadband disturbance, is noncausal. As well known, it is impossible to realize such a filter in an online application. Thus, the delayed reference signal is unusable for broadband noise cancellation. This simulation investigates the effect of an added coherent but delayed signal with respect to controller performance. For simulation purposes, the disturbance and reference signals were used as follows

$$d(n) = \mathbf{F}_e(z) \cdot s_1(n) \quad (17)$$

$$x_1(n) = \mathbf{F}_{rr}(z) \cdot s_1(n) \quad \text{and} \quad x_2(n) = \mathbf{F}_{rl}(z) \cdot s_1(n). \quad (18)$$

The employed transfer functions conform to the situation illustrated in Figure(3). Thus, the transfer function $F_{rl}(z)$ engendering $x_2(n)$ includes a greater time delay than $F_e(z)$ producing the disturbance $d(n)$ to be cancelled out. The controller set up was realized as described above.

6 Results

The results of the simulations are presented in the following figures.

Figure (6) and Figure (8) illustrate the accomplished attenuation through a representation of the spectra of the error microphone signal for the controlled and the uncontrolled cases. A broadband attenuation of the disturbance was reached up to 6 kHz.

The values of the parameters of the optimal filters obtained after convergence are illustrated in Figure (7) and Figure (9). The simulation shows that in both cases, the unusable signals (the incoherent and the delayed) were recognized and inhibited by the controller. Thus, it appears that all parameters of the filters, which deal with the unusable signals converged to zero. The parameters of the filters, which deal with the appropriate references converged to the solutions illustrated in the same figures (7) and (9). The represented parameters describe the impulse responses of the calculated optimal filters.

Obviously, the proposed 2-channel feedforward controller is able to handle any reference signal regardless of coherence and time delay. The inappropriate signals will be recognized and inhibited, while the appropriate signals will be passed through and filtered out such that they attenuate the disturbance. Concerning this controller, the direction from which the primary noise propagates is not a barrier for successful control, since at least one reference signal is less time delayed than the disturbance.

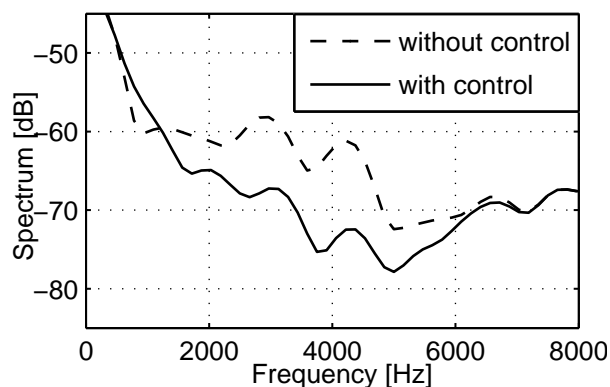

Figure 6: Control result

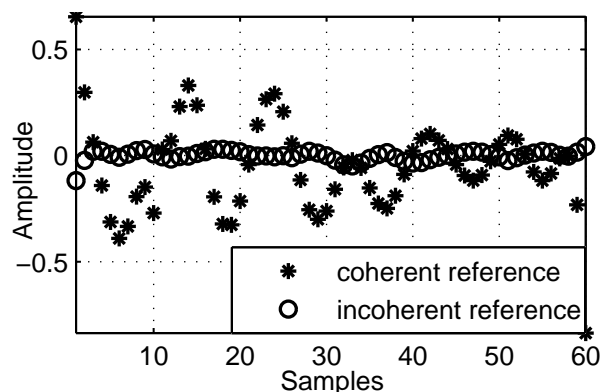

Figure 7: Optimized filter parameters

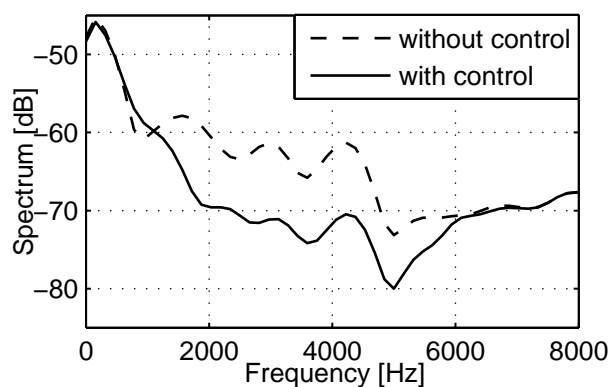

Figure 8: Control result

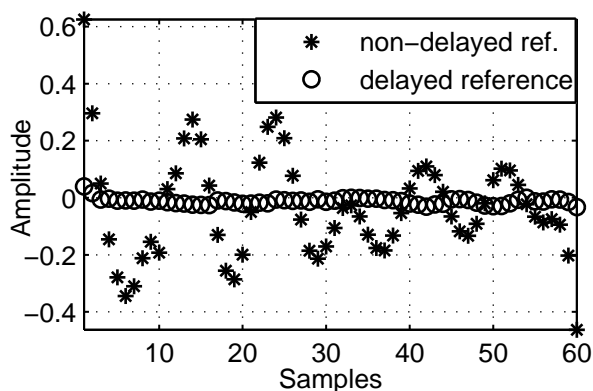

Figure 9: Optimized filter parameters

References

- [1] S.M. Kuo and D.R. Morgan: *Active Noise Control Systems Algorithms and DSP Implementations*. Wiley-Interscience Publication, New York 1996.
- [2] S.J. Elliott and P.A. Nelson: *Active Noise Control*. IEEE Signal Processing Magazine, 10(4), pp 12-35. 1993.
- [3] B. Widrow: Adaptive filters. In *Aspects of Network and Systems theory*. R.E. Kalman and N. DeClaric. Holt, Reinhart and Winston, New York 1970. pp. 563-87.